

90° ANGLE DIE GRINDER 0.5 CV WITH 6MM RETAINER

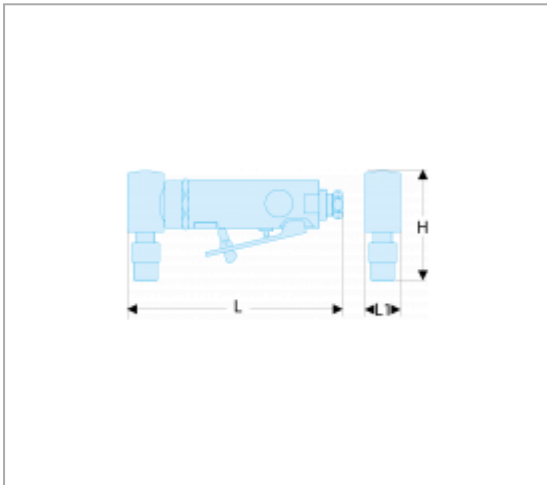

Description :

- 90° angle transmission to work on vertical surfaces.
- Tough “Soft grip” over molded rubber handles insulating against cold and vibrations.
- Air blown away to avoid projections on the operator.
- Built-in silencer and air exhaust pipe connection to lower noise.
- Excellent control with progressive trigger to control speed.



References :

	H [MM]	L [MM]	L1 [MM]	VIBRATION [M/S ²]	MAXIMUM RPM [MN]	[KG]
V.DGA505F	75	175	27	5,19 (K=1,14)	18500	780